



DWM-20A

COUNTERTOP SPARKLING WATER DISPENSER

MODwater

DWM-20A
02/18/20
Item # 13502

W x D x H
14⁷/₈" x 21¹/₂" x 16⁵/₈"



**DWM-20A shown on
C-80BAJ**



Refrigeration
Equipment
CANCSA-C22.2
No. 120



LISTED
Drinking Water
Coolers UL-399



* if placed on
countertop
less than 33"

Item #: _____
Project: _____
Qty: _____
AIA#: _____

Features

- ▶ **Four water options: Sparkling, Chilled, Hot, and Alkaline**
- ▶ **High capacity flow (20 gal/hour) with compact size** (fits under cabinets)
- ▶ **Attractive modern design with LED touch buttons**
- Eco-friendly: reduces plastic water bottle use
- Provides healthy water beverage options
- Stainless steel body with black polycarbonate button panel
- SEC Chiller Technology (Smart, Efficient, Compact)
- Patented in-line carbonator provides superior sparkling water
- Drain pan can be connected to a drain or used as a drip pan
- Hot water safety switch and LED indicator
- Filter status LED indicator
- Designed to fit perfectly on top of AM-50/C-80 undercounter ice machines (same width and depth)
- Button height complies with ADA standards when mounting surface is 33.5" or less in height
- Installation kit included**
- 10.25" cup clearance

Warranty: Three Year Parts and Labor

Shipping: (LxWxH) 25.4" x 19.5" X 23.6" **Volume:** 5.50ft³

Model	Max Draw of Chilled Water (Chilled or Sparkling)	Max Flow Rate (Chilled)	Heat Rejection	Refrigerant Type / Charge	Max. Fuse Size or HACR Circuit Breaker	Max Amps	Voltage	Net / Ship Weight (lbs.)
DWM-20A	20 gal/hour	0.9 gal/min	450W	R-134a / 4.23 oz	15A	9A	120/60/1	73* / 90

*Unit in operation/filled with water weighs 93 lbs.
5⁷/₈ ft. power cord included.

Types of Water Dispensed

Chilled	Temp.	34°-36°F
Sparkling	Carbonation	3.7 Vol.
Alkaline	pH (avg.)	8.0-9.0
Hot	Factory set	185°F

Options/Accessories

- Replacement Water Filter: (2) all-in-one filters with ultra-filtration membrane (0.1 micron) external to the appliance (HS-5441)
- Replacement Alkaline Chamber (internal) (HS-5442)
- Mounting Brackets for placing atop AM-50 or C-80 ice machine
- 6 month Replacement kit: (2) alkaline chamber, air filter, nozzle tip with aerator. (HS-5504)

Operating Limits

- Ambient Temp Range 41°-90°F
- Water Temp Range 41°-85°F
- Water Pressure Range 45-80psi
- Water Press. Range (recommended) 45-65psi
- Voltage Range 104-127V

Standard Package Includes**

- DWM-20A water dispenser
- Filter pack
- Leak detector
- Shut off valve
- Alkaline chamber
- CO₂ regulator
- Installation hose kit
- Water pressure regulator
- Angle stop valve

Plumbing

- Water supply line: 3/8" - max 80psi (with water flow regulator, provided)
 - CO₂† supply connection: 1/4" with CO₂ regulator set at 55 psi
 - Drain line: 3/8" (optional line)
- †CO₂ to be sourced from third party vendor

NOTE: CO₂ tank for sparkling water be sourced locally by end-user.

Hoshizaki reserves the right to change specifications without notice.



DWM-20A

COUNTERTOP SPARKLING WATER DISPENSER

MODwater

DWM-20A
02/18/20
Item # 13502

FRONT VIEW

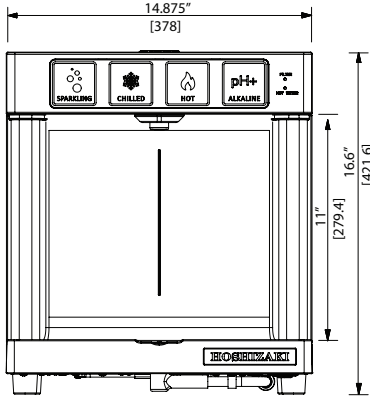

SIDE VIEW

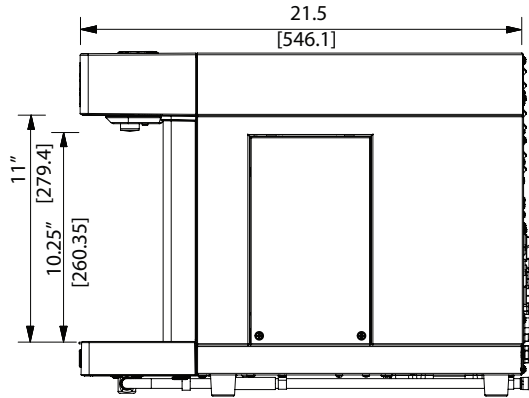

REAR VIEW

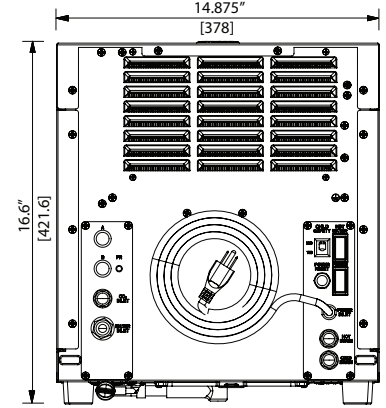

inch
[mm]

DWM-20A - Allow 4" clearance at rear and on sides.

DWM-20A - 5' 10" power cord included

BOTTOM VIEW

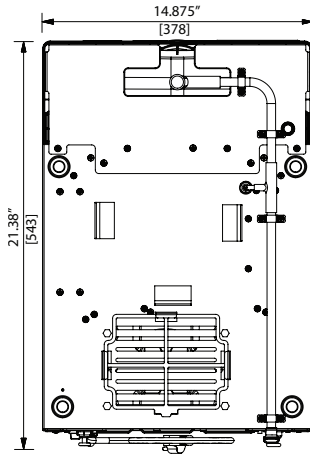

FRONT VIEW

Shown on C-80BAJ (Cubelet ice) or AM-50BAJ (Gourmet ice)

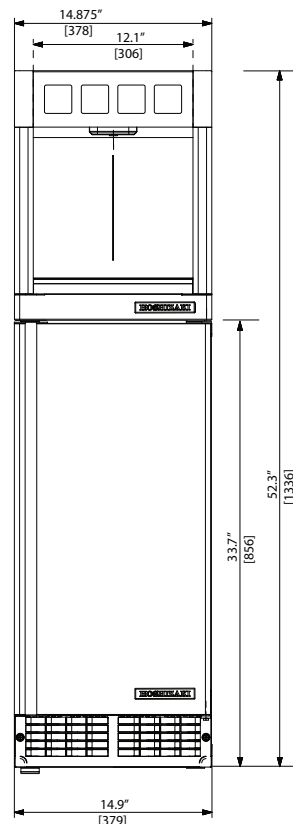

SIDE VIEW

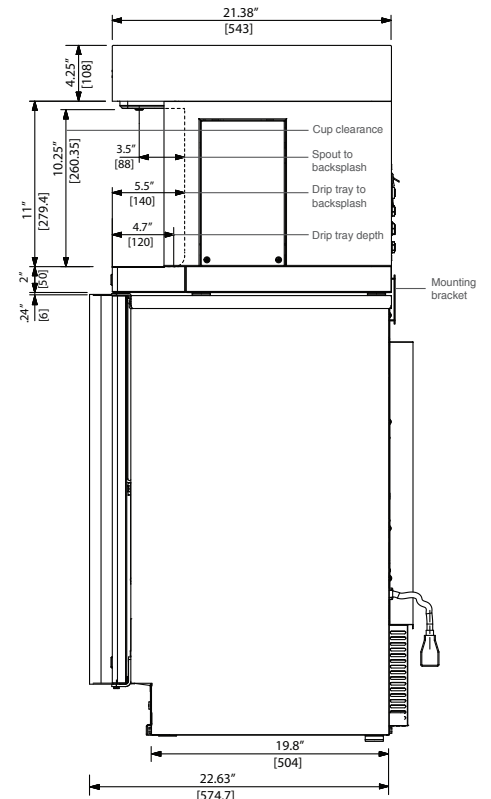

TOP VIEW

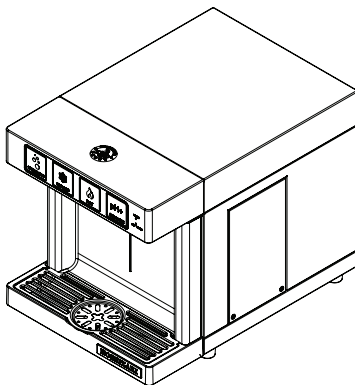

DWM-20A - 5' 10" power cord included