



INSTALLATION AND OPERATING MANUAL

P/N 20-44626

SELF-SERVICE, GRAB-N-GO
MERCHANTISERS / HEATED SHELVES /
FRONT CONTROL PANEL / CERAMIC
METAL HALIDE LIGHTS



Important! See Installation Section Of This Manual For Specifics On Confirming Proper Placement of "Danger-Hot" Labels on Heated Shelves and Deck

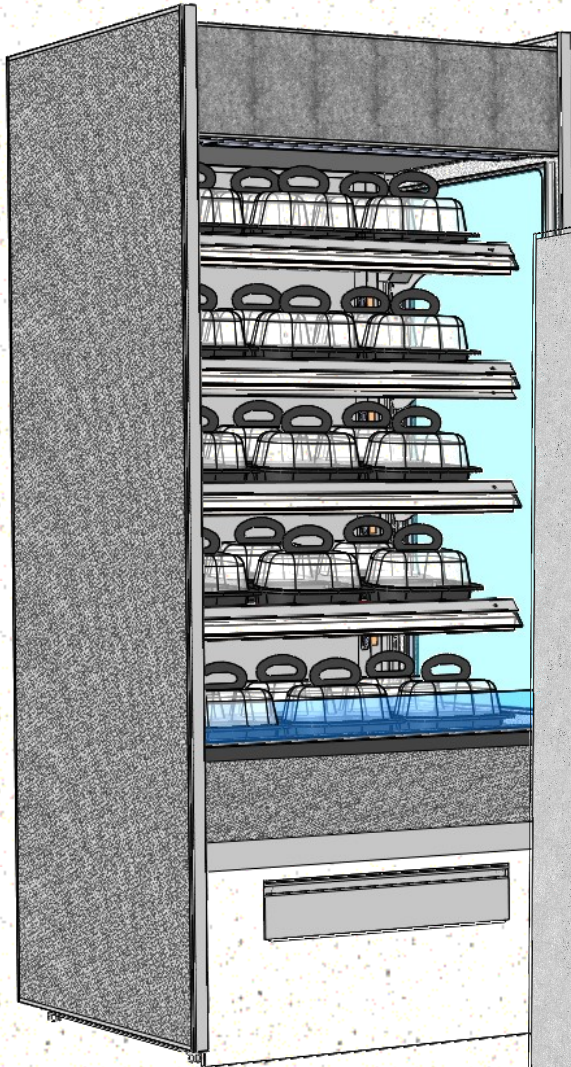

Model B3632H

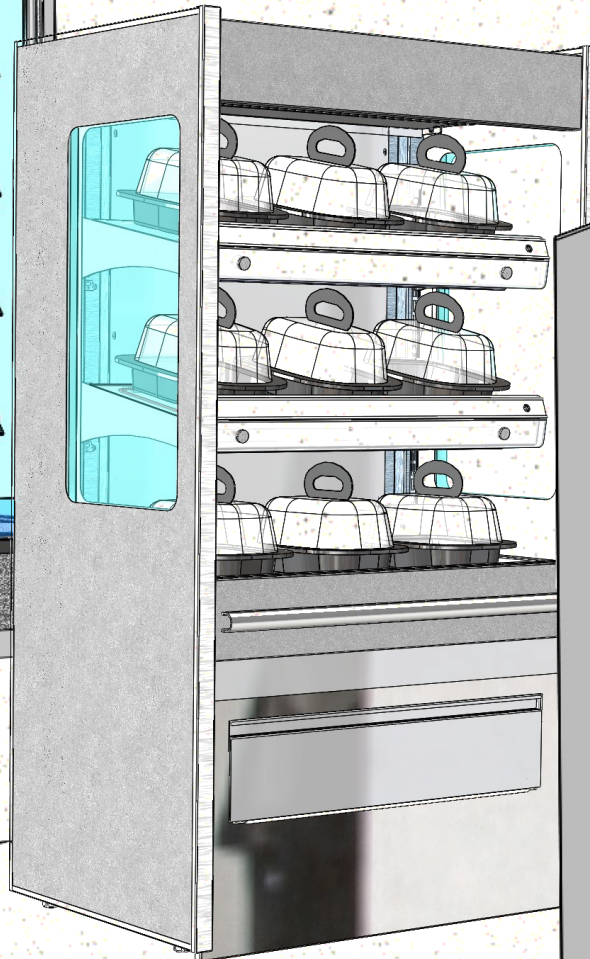

Model B22H.6818H

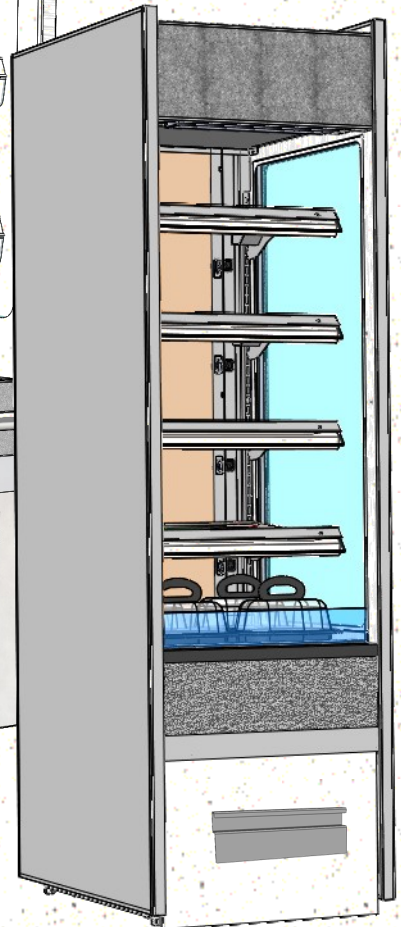

Model B2432H



TABLE OF CONTENTS

OVERVIEW / TYPE / COMPLIANCE / WARNINGS / PRECAUTIONS / WIRING / PLUGS	3-4
INSTALLATION: CASE REMOVAL / POSITIONING & ALIGNING CASE	5
INSTALLATION, CONTINUED: IMPORTANT! HEATED SHELF LABEL PLACEMENT	6
INSTALLATION, CONTINUED: POSITIONING / ALIGNING / REMOVABLE FRONT & REAR PANELS	7
STARTUP: MAIN POWER SWITCH / LIGHTS SWITCH / FRONT PANEL REMOVAL / ELECTRICAL RACEWAY	8
STARTUP, CONTINUED - CONTROL PANEL EXPLODED VIEW (MODEL B2432H ONLY)	9
STARTUP, CONTINUED - CONTROL PANEL EXPLODED VIEW (MODEL B3632H ONLY)	10
STARTUP, CONTINUED - CONTROL PANEL EXPLODED VIEW (MODEL B22H.6818H ONLY)	11
STARTUP, CONTINUED - OPERATION AND SHUTDOWN (TO BE PERFORMED BY AUTHORIZED PERSONNEL ONLY!)	12
CERAMIC METAL HALIDE LIGHT FIXTURES / REPLACEMENT / POLYCARBONATE HEAT SHIELDS	13
SERIAL LABEL & LOCATION / TECHNICAL INFORMATION / ADD'L INFORMATION	14
CLEANING SCHEDULE (DAILY / WEEKLY) - CASE EXTERIOR	15
CLEANING SCHEDULE (DAILY / WEEKLY) - CASE INTERIOR	16
TROUBLESHOOTING	17
SCC TECHNICAL SERVICE CONTACT INFORMATION & WARRANTY INFORMATION	18

OVERVIEW

This merchandiser is designed for dry heating operations throughout the product area. The heat is generated from shelving, deck and overhead ceramic metal halide lamps.

- Cases should be installed and operated according to this operating manual's instructions to insure proper performance.
- These Structural Concepts® self-service heated merchandisers are designed to hold pre-heated hot foods at 140 °F to 165 °F (60 °C to 74 °C).
- Product must be pre-heated to these temperatures PRIOR TO being placed in merchandiser. This case is NOT designed to heat product from cold or ambient conditions.
- This merchandiser is designed for display of perishable, packaged products.
- Overhead ceramic metal halide lamps are used throughout merchandiser.
- Improper use will void warranty.

GENERAL OPERATIONAL CONDITIONS

This unit has been tested in and designed for the display of products in ambient store conditions where temperatures and humidity are maintained within a specific range.

- Ambient conditions are to be at 55% max. humidity and a maximum temperature of 75 °F (24 °C).

INTEGRATED AVERAGE PRODUCT TEMPERATURE

- These units are designed to merchandise product at an integrated average product temperature of 150 °Fahrenheit / 66 °Celsius.

THERMOMETERS

- Thermometers in equipment reflect internal air temperature only (not actual food temperature).
- Use probe thermometers to determine actual product temperatures.

COMPLIANCE

- Performance issues when in violation of applicable NEC, federal, state and local electrical and plumbing codes are not covered by warranty. See below.

WARNINGS

- This page contains important warnings to prevent injury or death. Please read carefully!

PRECAUTIONS, CORD/PLUG & WIRING DIAGRAMS

- See next page for **WARNINGS, PRECAUTIONS, CORD/PLUG** and **WIRING DIAGRAM** information.



ATTENTION CONTRACTORS

COMPLIANCE
This equipment **MUST** be installed in compliance with all applicable NEC, federal, state and local electrical and plumbing codes.



WARNING
Risk of electric shock. Disconnect power before servicing unit. **CAUTION!** More than one source of electrical supply is employed with units that have separate circuits. *Disconnect ALL ELECTRICAL SOURCES before servicing.*



WARNING
Shelves and Decks Are Hot! Disconnect and allow to cool 45 minutes before cleaning or removing from case. Ceramic metal halide lamps are hot! Turn off or disconnect and allow to cool 45 minutes before servicing or replacing.



WARNING: This product can expose you to chemicals, including Urethane (Ethyl Carbamate), which are known to the state of California to cause cancer and birth defects or other reproductive harm. For more information go to P65Warnings.ca.gov.

PRECAUTIONS

- Following are important precautions to prevent damage to unit or merchandise.
- Please read carefully!
- See previous page for specifics on **OVERVIEW**, **TYPE**, **COMPLIANCE** and **WARNINGS**.

POWER CORD AND PLUG MAINTENANCE

- Caution! Risk of electric shock.

- If cord or plug becomes damaged, replace only with cord and plug of same type.

WIRING DIAGRAM

- Each case has its own wiring diagram folded and in its own packet.
- Wiring diagram placement may vary; it may be placed near ballast box, field wiring box, raceway cover, or other related location.



CAUTION! LAMP REPLACEMENT GUIDELINES
 Ceramic metal halide lamps reflect specific size, shape and overall design. Any replacements must meet factory specifications. Ceramic metal halide lamps must be replaced with similar lamps.



CAUTION! GFCI BREAKER USE REQUIREMENT
 If N.E.C. (National Electric Code) or your local code requires GFCI (Ground Fault Circuit Interrupter) protection, you **MUST** use a GFCI breaker in lieu of a GFCI receptacle.



CAUTION! POWER CORD AND PLUG MAINTENANCE
 Risk of electric shock. If cord or plug becomes damaged, replace only with cord and plug of same type.

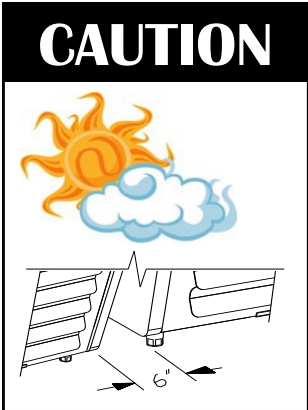

CAUTION! ADVERSE CONDITIONS / SPACING ISSUES

- Performance issues caused by adverse conditions are **NOT** covered by warranty.
- End panels must be tightly joined or kept at least **6-inches** away from any structure to prevent condensation.
- Unit must be kept at least **15-feet** from exterior doors, overhead HVAC vents or any air curtain disruption to maintain proper temperatures.
- Do not expose to direct sunlight or heat source (ovens, fryers, etc.).
- Keep at least **8-inch** clearance above unit for air discharge (self-contained units only).

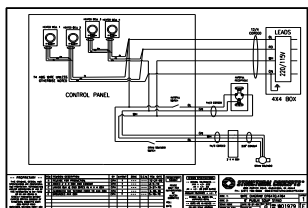

WIRING DIAGRAM FORMAT & LOCATION

- Each case has its own wiring diagram folded & in its own packet.
- Wiring diagram placement may vary; it may be placed near ballast box, field wiring box, raceway cover, or other related location.

INSTALLATION: CASE REMOVAL / POSITIONING & ALIGNING CASE

1. Remove Case From Skid (Levelers)

- Remove shipping brace that may be securing case to skid.
- Support case to prevent tipping.
- **Caution! Levelers can be damaged if case hits floor with heavy force!**
- Carefully slide unit to rear of skid and tip backward off skid.
- Illustration may not reflect every feature or option of your particular case.

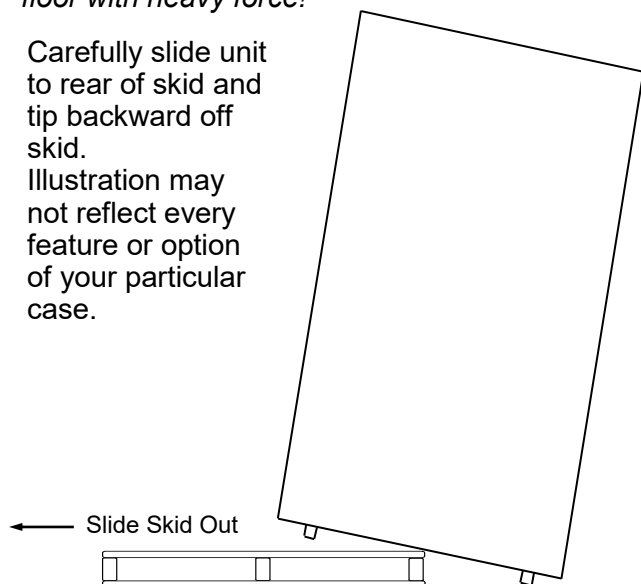

Case can be repositioned with pallet truck when front lower panel is removed. Blocking may be necessary to obtain adequate height.

2. Remove Case From Skid (Casters)

- Remove shipping brackets that may be securing casters to skid
- Place ramp up against skid (to allow case to smoothly slide off from skid).
 - Maintain support of case at all times or center of gravity may cause case to fall.
 - Unlock Casters. Roll unit to rear of skid.

Roll down ramp and off from skid.

Note: Illustrations shown reflect a general outline of sample cases and do not reflect features or options of your particular model.

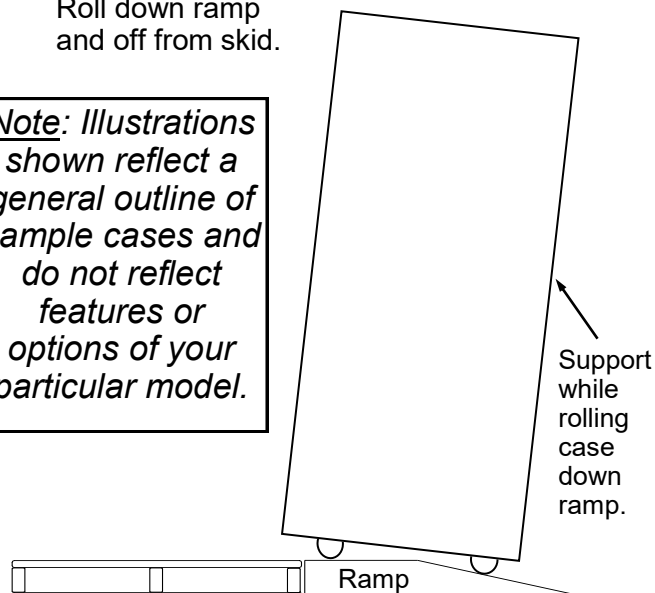

3. Position & Align Case Alongside Other Cases

- Before adjusting levelers, make certain that the case is in proper position and, if required, aligned with adjoining case(s).
- This may require the repositioning of the case you are installing or the already positioned case(s).

4. Adjust Levelers

- After case is in proper position, adjust case so it is level and plumb (see illustration at right).
- You may need to remove front and/or rear Toe-kick to access levelers.
- Use adjustable wrench to adjust leveler.
- Depending upon case weight it may be necessary to use a pry bar to accomplish this task.
- Do not use pry bar on toe-kick as it may buckle.
- Do not use pry bar on end panel as it may chip.
- Use pry bar **ONLY** on base frame to avoid damaging case.
- See illustration and photos at right.

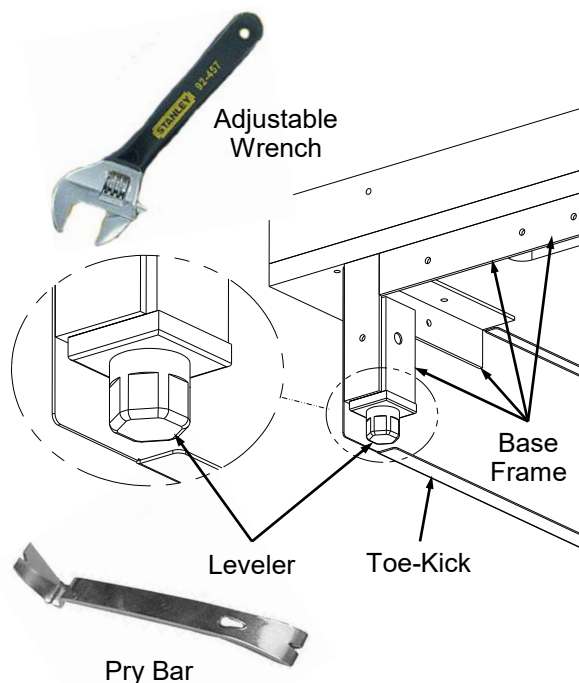

5. Important! Check That “Caution-Hot” Labels Are Properly Attached To Case

- Shelves can get extremely hot and cause severe burns.
- Illustration below shows proper placement of “Caution-Hot” labels.
- At least ONE label must be placed on each shelf (as shown below). Wide units may have two or more labels placed on shelves and deck.
- If labels are not properly attached, contact Structural Concepts to obtain labels. See **SCC TECHNICAL SERVICE CONTACT INFORMATION** section at last page in manual.

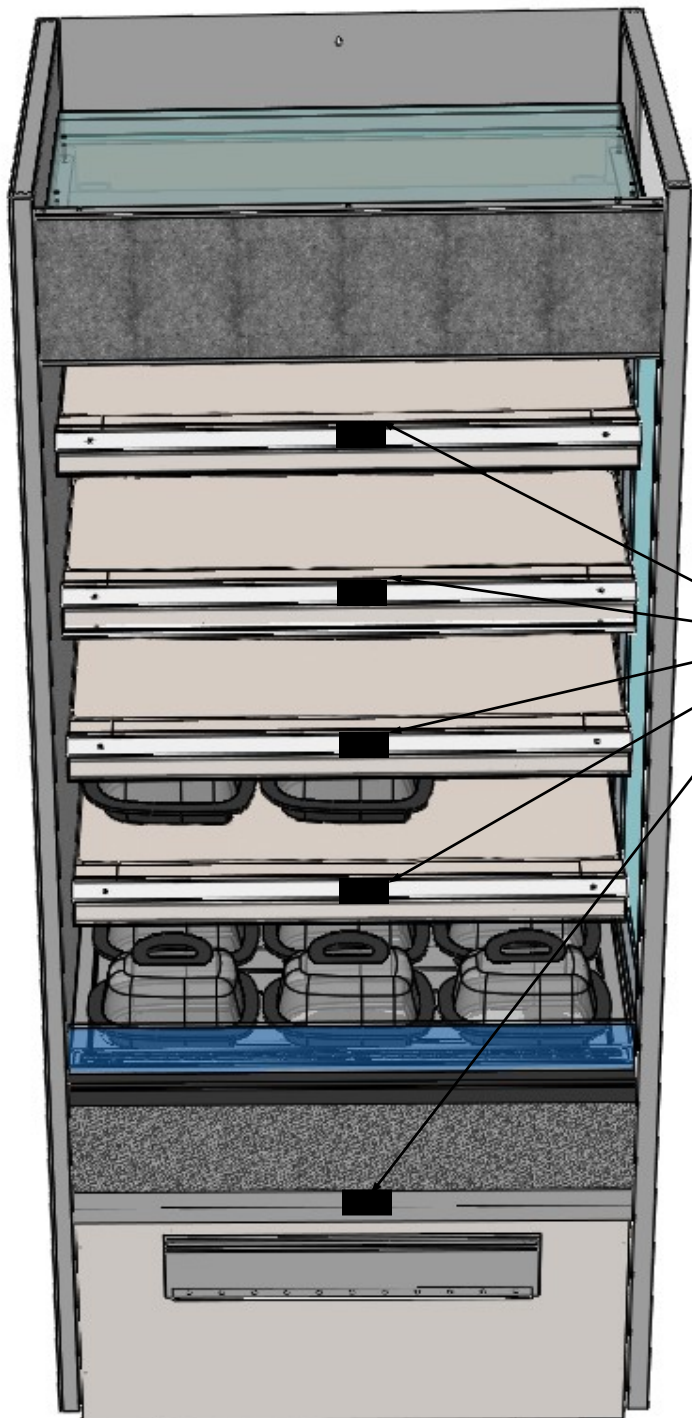

Illustration Shown May Not Exactly Reflect Every Feature or Option of Your Particular Case.



Important! Check That “Caution-Hot” Labels Are Placed On Heated Shelves and Deck As Shown In Illustration At Left

6. Removable Front & Rear Panels

- Front panels are removable by simply sifting up and off (via slot/hook method). See illustration below.
- Rear panels are removable by accessing four (4) screws. See illustration below.
- Return to case in reverse order it was removed.

Illustrations Shown May Not Exactly Reflect Every Feature or Option of Your Particular Case.

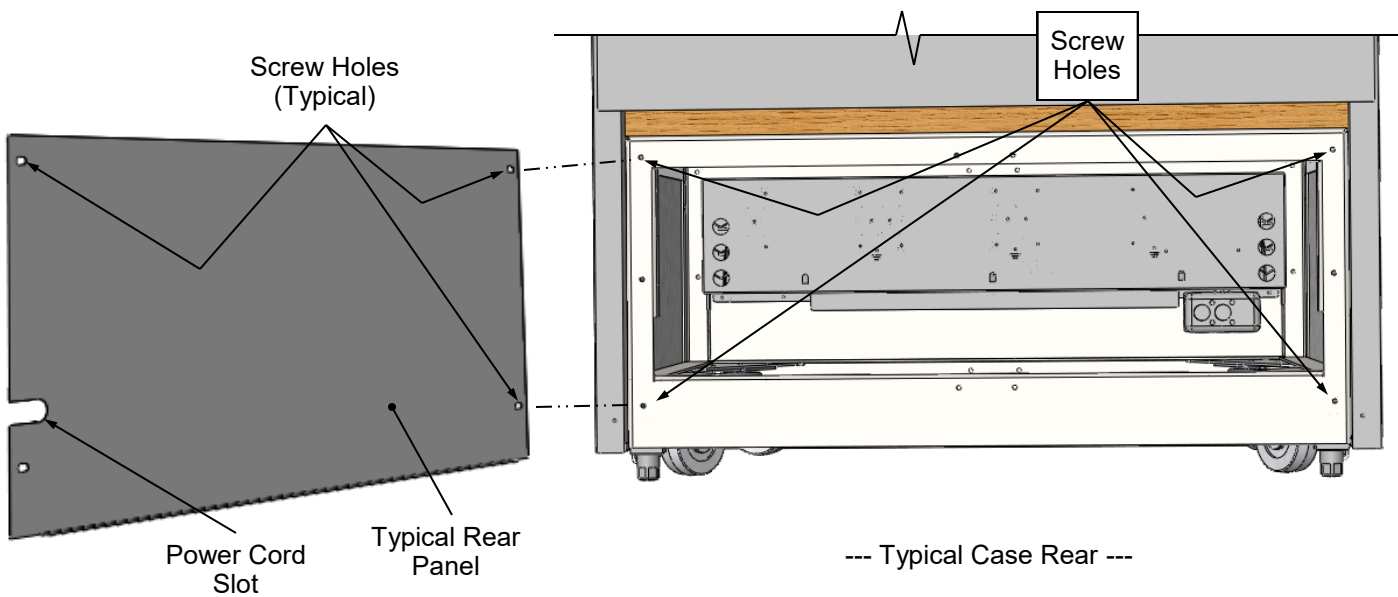
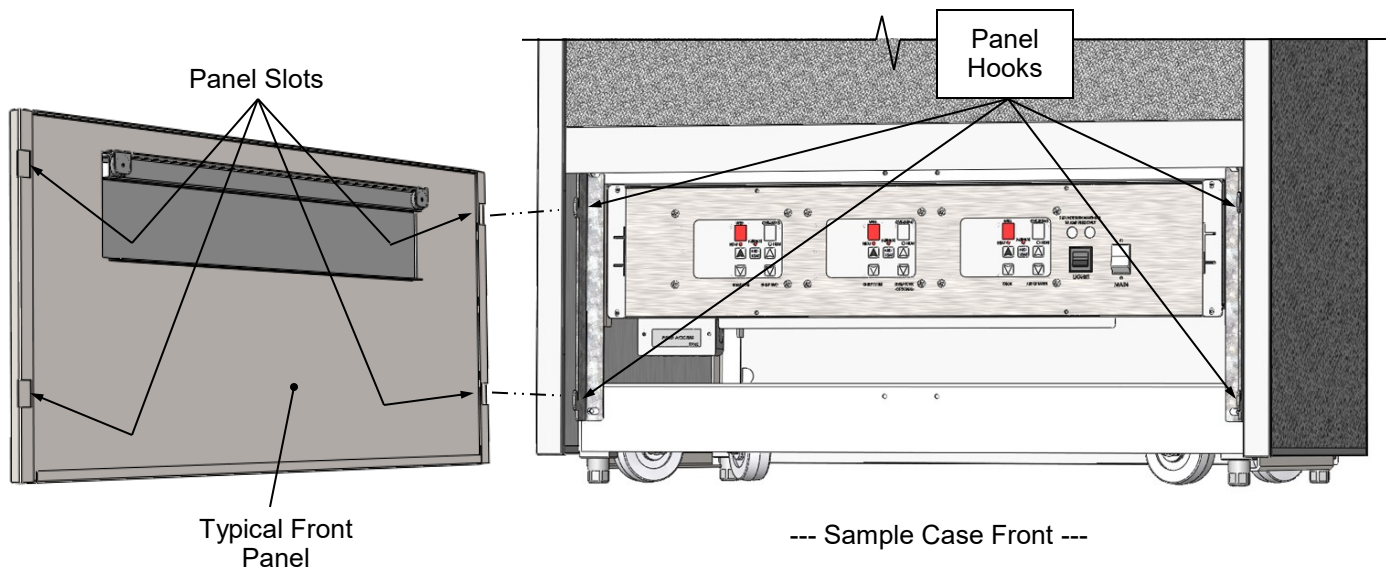

1. Front Flip-Down Door / Main Power / Lights

- Models have flip-down door with magnet features allowing access to controls at front of case.
- Main power switch, lights and pre-heat buttons are accessible when down-down door is lowered.
- When main power switch is turned on, power to entire case is provided.
- When light switch is turned on, all lights in entire case will turn on.

2. Front/Rear Panel Removal

- To remove front (or rear) panels, lift front panel up and off case. No screw removal is required to remove front panel.

- Certain models employ magnets along with slot/hook method on front/rear panels.
- Replace front/rear panels in same manner they had been removed.

3. Electrical Raceway Access

- Directly behind front (or rear) panel is the electrical raceway.

Note: Model B3632H Is Shown With Flip-Down Door Removed. General Layout Is Applicable To All Models Represented In This Operating Manual.

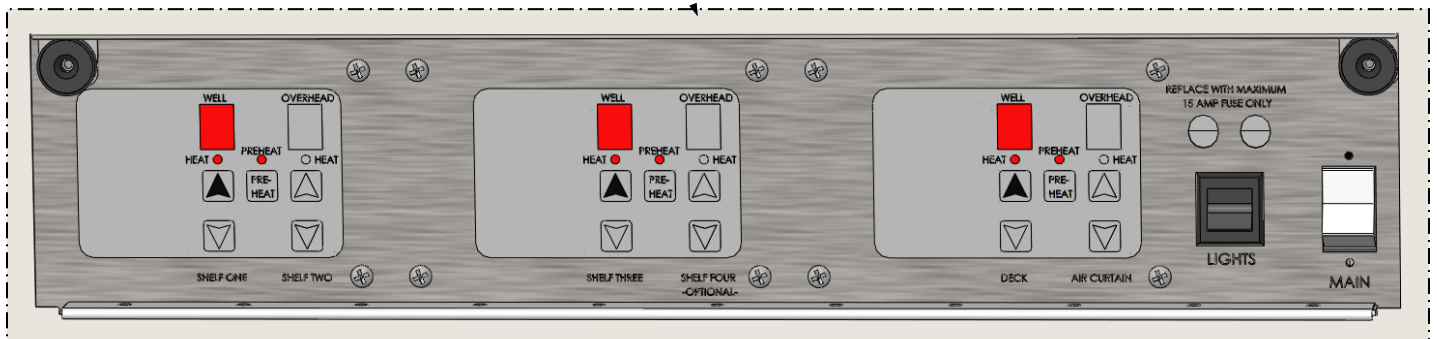
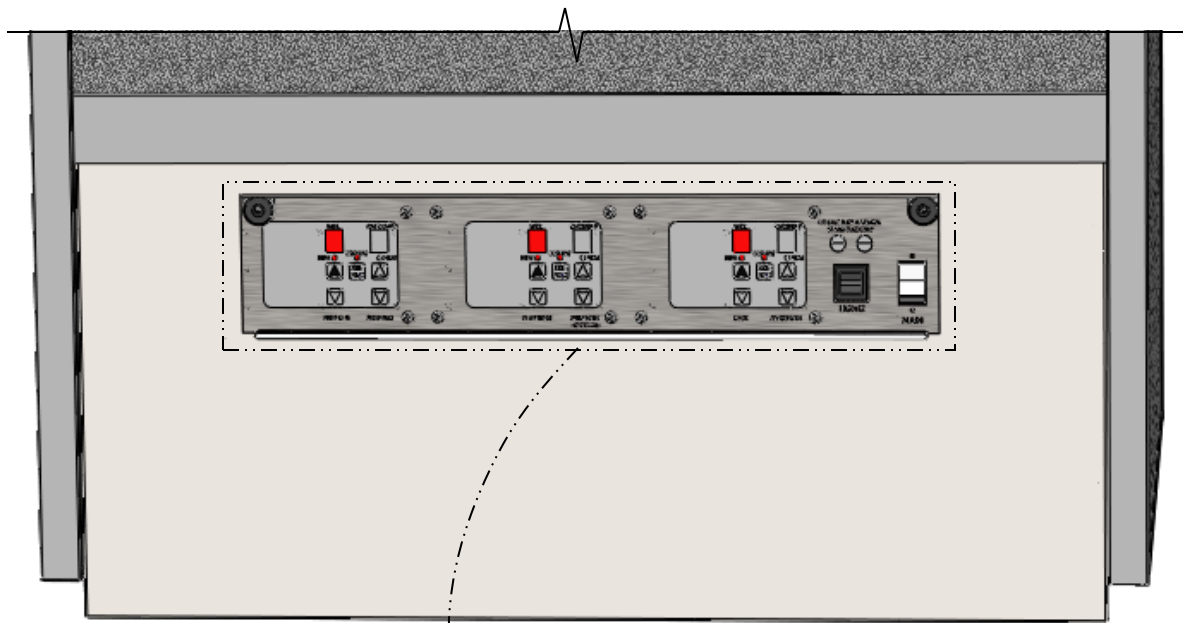

STARTUP, CONTINUED - CONTROL PANEL EXPLODED VIEW (MODEL B2432H ONLY)

Model B2432H - Control Panel Exploded View

1. Field Access Box

- Field access box is at lower-left of control panel.

2. Main Power / Lights

- Main power switch and lights switch are at right of control panel (as shown below).

3. Inoperative Dashboard Notations

- Markings of "Well," "Overhead" and "Pre-Heat" may be on faceplates.
- These functions are NOT used on these models and are to be disregarded.

4. Shelves and Deck Heater Controls

- Heater controls to shelves and deck are on control panel.
- Heat is controllable by the pressing the "up" and "down" arrows on faceplate. The red "HEAT" light will come on when shelves (or deck) are warming.

5. Fuse

- Replacement fuse must be 15 amp maximum.

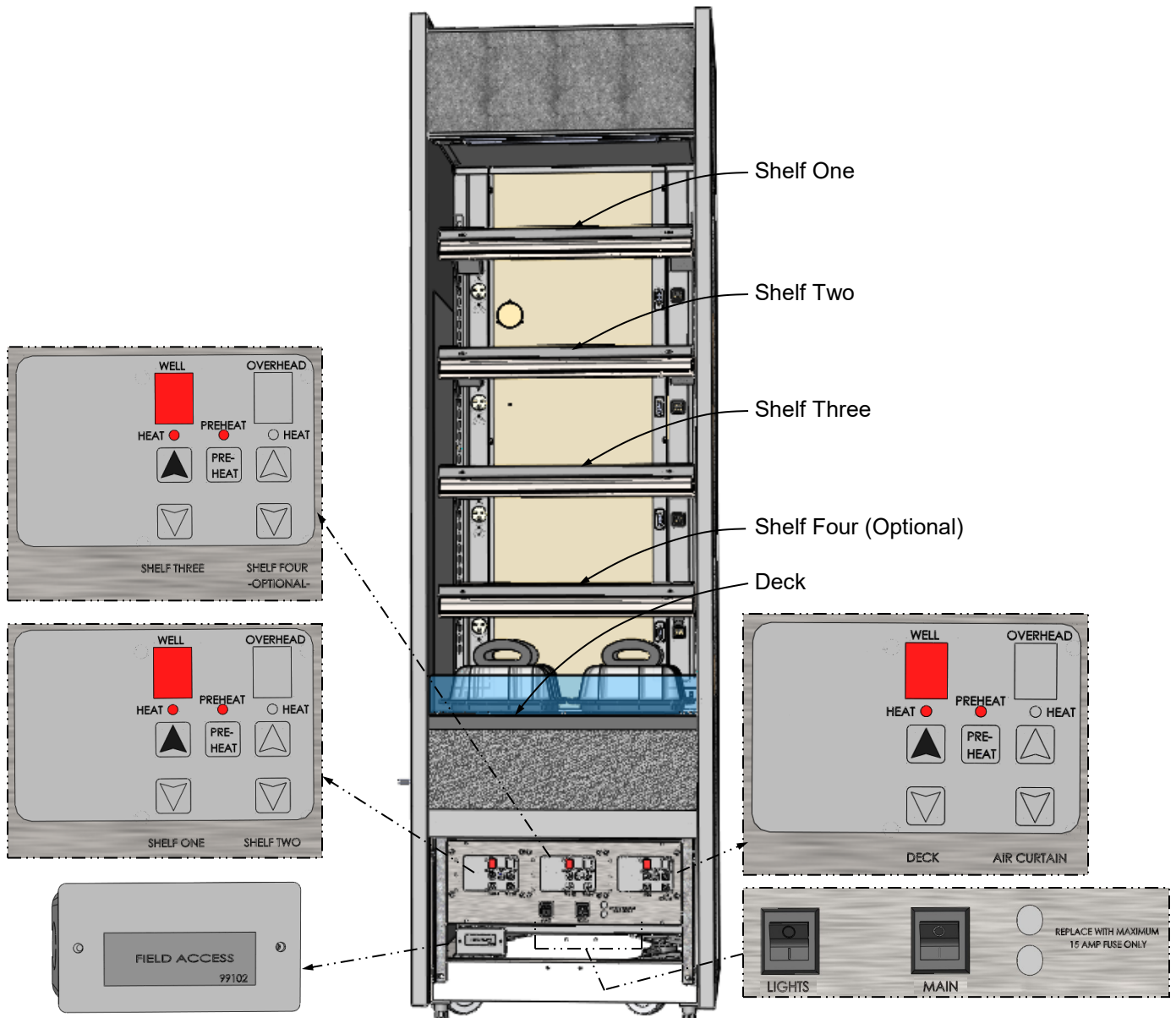

STARTUP, CONTINUED - CONTROL PANEL EXPLODED VIEW (MODEL B3632H ONLY)

Model B3632H - Control Panel Exploded View

1. Field Access Box

- Field access box is at lower-left of control panel (as shown in illustration below).

2. Main Power / Lights

- Main power switch and lights switch are at right of control panel (as shown in illustration below).

3. Inoperative Dashboard Notations

- Markings of "Well," "Overhead" and "Pre-Heat" may be on faceplates.

- These functions are NOT used on these models and are to be disregarded.

4. Shelves and Deck Heater Controls

- Heater controls to shelves and deck are on control panel.
- Heat is controllable by the pressing the "up" and "down" arrows on faceplate. The red "HEAT" light will come on when shelves (or deck) are warming.

5. Fuse

- Replacement fuse must be 15 amp maximum.

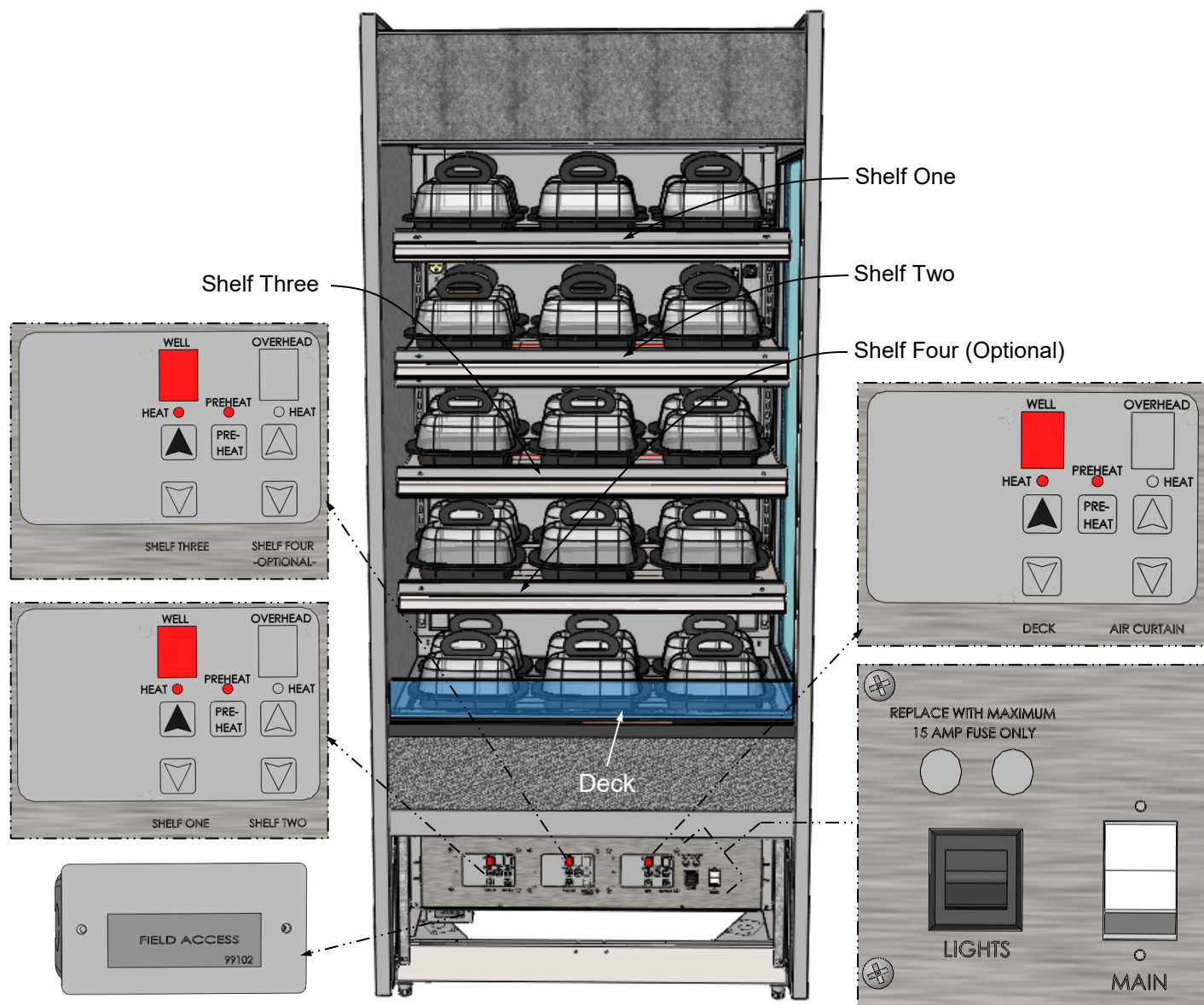

STARTUP, CONTINUED - CONTROL PANEL EXPLODED VIEW (MODEL B22H.6818H ONLY)

Model B22H.6818H - Control Panel Exploded View

1. Field Access Box

- Field access box is at lower-left of control panel (as shown via transparent front panel below).

2. Main Power / Lights

- Main power switch and lights switch are at right of control panel (as shown in illustration below).

3. Inoperative Dashboard Notations

- Markings of "Well," "Overhead" and "Pre-Heat" may be on faceplates.
- These functions are NOT used on these

models and are to be disregarded.

4. Shelves and Deck Heater Controls

- Heater controls to shelves and deck are on control panel.
- Heat is controllable by the pressing the "up" and "down" arrows on faceplate. The red "HEAT" light will come on when shelves (or deck) are warming.

5. Fuse

- Replacement fuse must be 15 amp maximum.

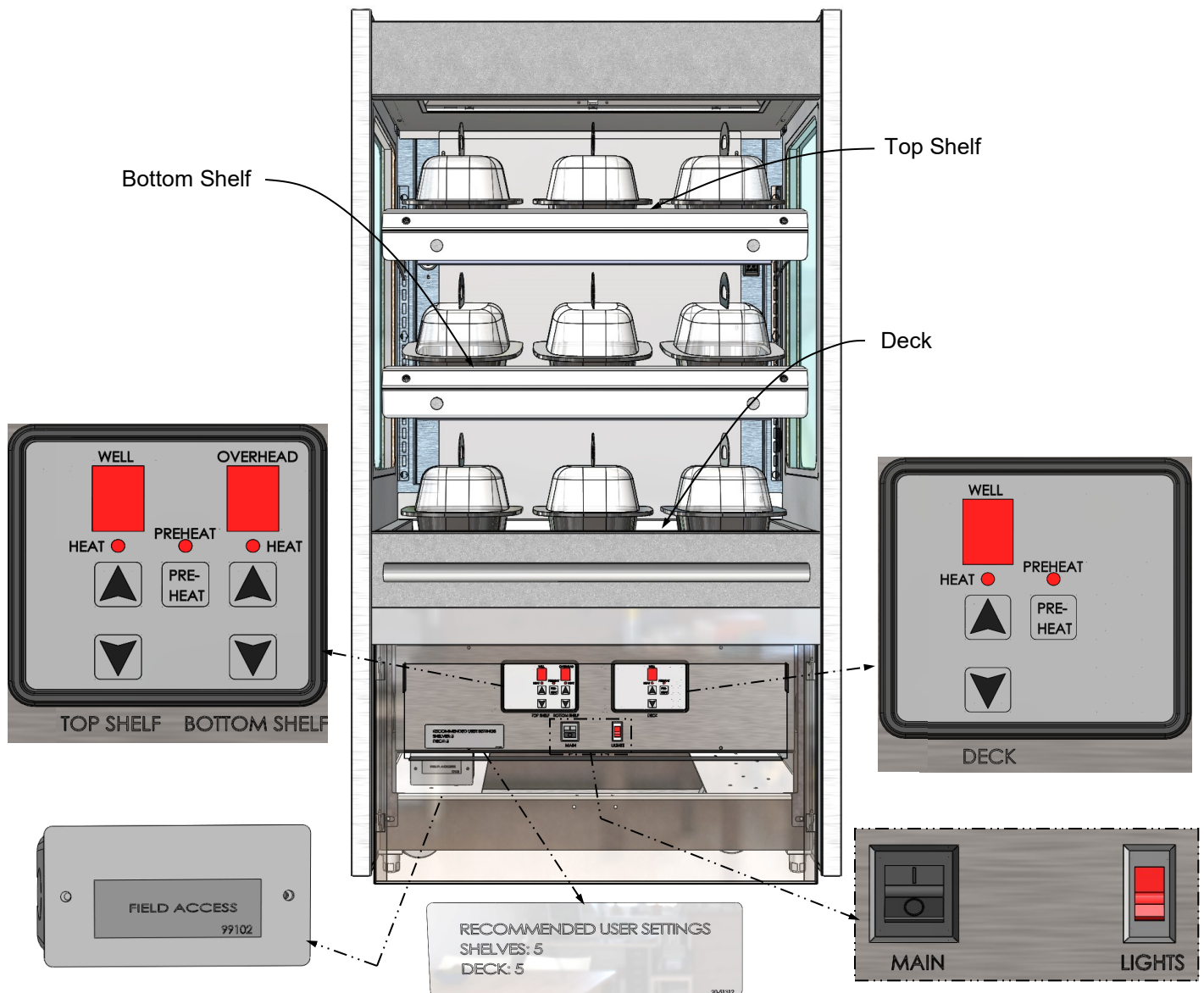

STARTUP, CONTINUED - OPERATION AND SHUTDOWN (AUTHORIZED PERSONNEL ONLY!)

1. Merchandiser Daily Start-Up (For Authorized Personnel Only)

- Lift up hinged door at case front. Both switches should be in off position.
- Turn main power switch / lamp switch on.
- **Inoperative Dashboard Notations:** Markings of “Well,” “Overhead” and “Pre-Heat” may on faceplates. These functions are NOT used on these models and are to be disregarded.
- **Ceramic Metal Halide Note:** Lamps may take up to 15 minutes to fully illuminate.
- **Heat Controller Note:** Heat is controllable by the “up” and “down” arrows on faceplates. Heat settings have a maximum setting of “9” and a minimum setting of “1”. A setting of “0” turns heat OFF. Default factory settings for user are “5”.
- **Cautionary Note:** Deck, shelving and overhead lights are hot! Do not touch unless dials have been turned off & area is cool!
- Heater controls to shelves and deck are on control panel.
- Heat is controllable by the pressing the “up” and “down” arrows on faceplate. The red “HEAT” light will come on when shelves (or deck) are warming.
- Allow 15-20 minutes for temperature to reach desired temperature before placing product on shelves/deck.
- Adjust controller until desired product temperature is reached.
- **Caution!** Food MUST BE cooked PRIOR to being placed in the case. Food should be heated to a temperature of between 150 °F to 160 °F (65.6 °C - 71 °C) prior to placing in case. Food temperature must NOT be allowed to be below FDA guideline of 140 °F (60 °C).
- Use probe to check food temperature before placing in case.
- After product is placed in case, check product temperature (again) after one hour to verify that proper food temperatures are maintained.
- Should product temperatures be outside of range, adjust temperature controls for that particular shelf or deck up or down by one number.
- Check food temperature again after one hour.

2. Temperature Control Settings

- Temperatures of all food products are to be at 140 °F to 165 °F (60 °C to 74 °C), for decks and shelves (including optional shelf #4).

3. Operating Tips

- When restocking, place new product at back and rotate older product to front of case.
- Display product expected to sell within 4 hrs.
- **Clean up residue immediately.** Case will cause spills and debris to harden to surface!

4. Shutting Down Case

- Remove all product from case. Turn main power switch “OFF.”
- Allow case to cool for 45 minutes before cleaning.

Note: Model B3632H Is Shown. General Layout Is Applicable To All Models Represented In Manual.

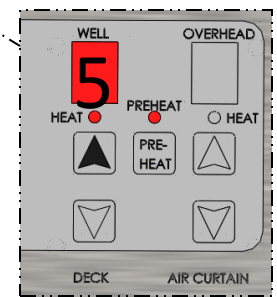
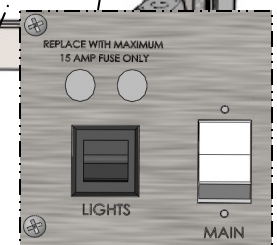
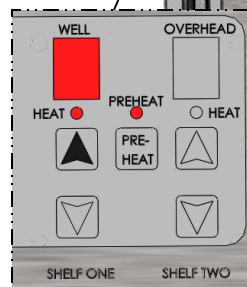
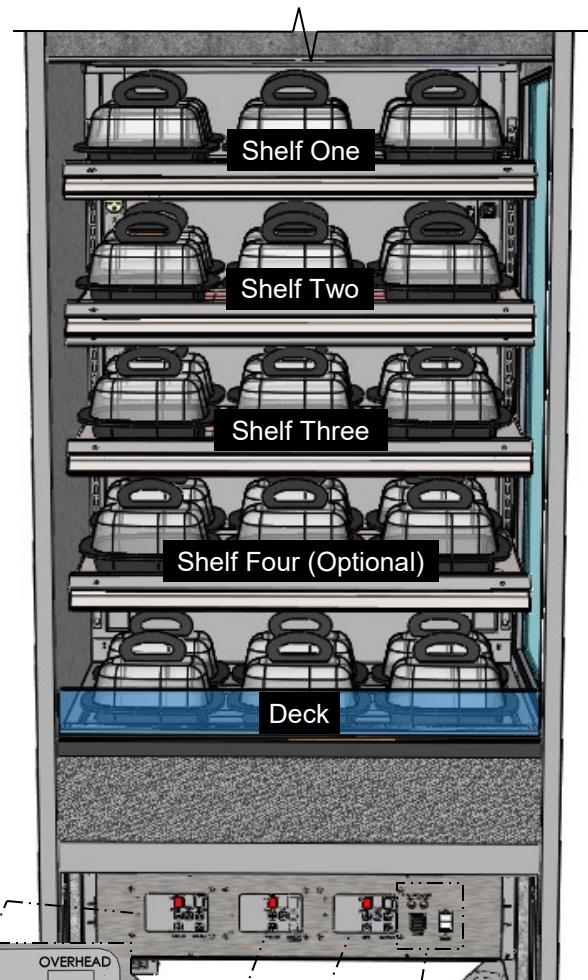

1. Ceramic Metal Halide Light Fixture Warnings

- ***Warning!*** Turn off lights switch before replacing ceramic metal halide lights.
- ***Warning!*** Lamps are manufactured to resist breakage. Replace with same wattage lamp that is similarly manufactured. If uncertain of wattage, refer to label on case for specifics.
- ***Warning!*** As ceramic metal halide lamps may heat up entire light fixture area, allow case to cool down for 45 minutes before accessing.

2. Removal of Ceramic Metal Halide Lamps

- Loosen lamp access screws. Allow lamp cover to drop downward.
- Wrap lamp in cloth or paper towel (as added protection from warm lamp).
- Grasp lamp with firm grip and pull straight outward (without bending or twisting lamp).

3. Installation of Ceramic Metal Halide Lamps

- Wrap new lamp in cloth or paper towel (as added protection from warm lamp AND to prevent oils from skin from getting on lamp).
- Firmly grasp and carefully insert into open socket.
- Raise lamp cover back into place. Tighten screws that had been loosened.
- Turn lamp switch back on. **Note:** Ceramic metal halide lamps may take up to 15 minutes to gain full illumination.

4. Polycarbonate Heat Shields

- Polycarbonate heat shields can heat up to extremely hot temperatures.
- Allow to cool before touching or cleaning.

Note: Illustration Shown May Not Exactly Reflect Every Feature or Option of Your Particular Case

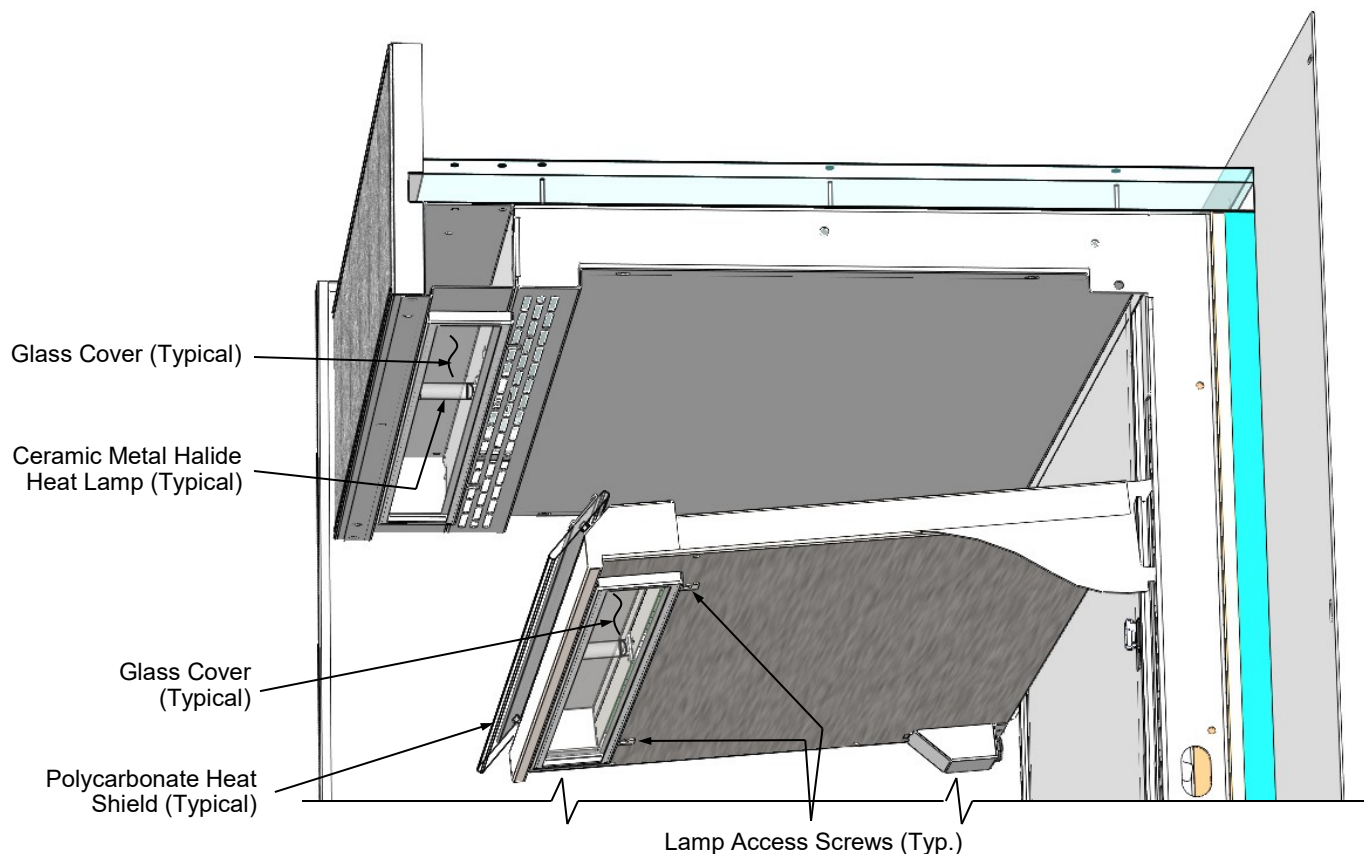

Serial Label Location & Information Listed / Technical Information & Service

- Serial labels are located near the electrical access on your case.
- Serial labels contain electrical, temperature & refrigeration information, as well as regulatory standards to which the case conforms.
- For additional technical information and service, see the *TECHNICAL SERVICE* page in this manual for instructions on contacting Structural Concepts' Technical Service Department.
- See images below for samples of both refrigerated and non-refrigerated serial labels.





888 E. Porter Rd · Muskegon, MI 49441

ENCORE[®] MODEL HV74RSS SCROLL
SERIES SERIAL NO.

FOR PARTS AND SERVICE
CALL 1-800-433-9489

SAMPLE ONLY

  3048256 CONFORMS TO UL STD 471 CONFORMS TO NSF STD 7 CERTIFIED TO CAN/CSA STD C22.2 NO 120	ELECTRICAL RATING REFRIGERANT DESIGN PRESSURE MINIMUM CIRCUIT MAXIMUM OVERCURRENT	120/1/60 24A R404A AMOUNT ?? OZ HIGH 450 LOW 200 30A 30A
---	---	--

SAMPLE ONLY

Super Heat Temp	8-10°F
BTUH Requirements	9,738 BTUH @ 20° F SST
Defrost	6 defrosts per day, 45° F termination, 45 min. failsafe

SAMPLE ONLY

----- Sample Serial Label For Refrigerated Case -----



888 E. Porter Rd · Muskegon, MI 49441

Addenda[®] PC5682 txtRemote
txtSerialNumber

120 VOLTS 60 HZ SINGLE PHASE 1.84AMP

FOR PARTS OR SERVICE CALL
STRUCTURAL CONCEPTS
AT
1-800-433-9489

SAMPLE ONLY

 3048256 CONFORMS TO UL STD 65 CERTIFIED TO CAN/CSA STD C22.2 NO 120	N/A
---	-----

----- Sample Serial Label For Non-Refrigerated Case -----

CLEANING SCHEDULE (DAILY / WEEKLY) - CASE EXTERIOR

Cleaning	Daily	Weekly	Task
Case Exterior	X		<p>Wood or Laminate Surfaces</p> <ul style="list-style-type: none"> • Clean with warm, soapy water and clean cloth or sponge. • Dry with clean cloth or paper towel.
	X		<p>Insulated Glass</p> <ul style="list-style-type: none"> • Clean outside surfaces of glass with household or commercial glass cleaner. • Dry with clean cloth or paper towel.
	X		<p>Stainless Steel (case top, sides, front, rear, etc.)</p> <ul style="list-style-type: none"> • Wash with solution of hand-dishwashing liquid detergent & warm water or solution of baking soda and water. Rinse and polish dry with paper towel or soft cloth. • Do not use scouring powders or steel wool as it will scratch surfaces. • Brighten by polishing with cloth dipped in vinegar or in ammonia; sprinkle baking soda on sponge and rub gently; rinse. Polish dry with paper towel. • Remove streaks or heat stains by rubbing with club soda. • Caution! Do not drip or spill cleaning solution into case!
		X	<p>Under Case Cleaning Remove front or rear panel. Clean under case with vacuum.</p>

CLEANING SCHEDULE (DAILY / WEEKLY) - CASE INTERIOR

Caution! TURN MAIN POWER SWITCH TO “OFF” and allow case to cool at least 45 minutes before cleaning case interior!

Cleaning	Daily	Weekly	Task
Case Interior	X		<p>Glass Clean inside surfaces of glass with a household or commercial glass cleaner. Wipe dry with clean cloth or paper towel.</p>
			<p>Polycarbonate Heat Shields (At Each Shelf)</p> <ul style="list-style-type: none"> • Use a liquid detergent and clean with a clean cloth. • Caution! Do not use glass cleaner on polycarbonate heat shields. Such cleaning solution will cause heat shield to become cloudy and cracked.
	X		<p>Shelves / Decks / Wire Racks Spills (Unhardened): Clean immediately to prevent hardening or “baking” of spills. Remove wire rack (if any) to access area. Use a dry cloth, folded over several times to clean up spills; this will prevent being burned due to steam from wet cloth on the hot surfaces. Spills (Hardened): Clean hardened spills with a damp cloth dipped in household cleaner. For stubborn stains, use firm-bristled nylon brush or scouring pad dipped in warm, soapy water. Use spray bottle with water and clean paper towel to wipe up residue. Wire racks may be removed, submersed in warm to hot soapy water, and cleaned with soft-bristled brush.</p>
		X	<p>Ceramic Metal Halide Glass Covers After case has been allowed to cool 45 minutes, use household or commercial glass cleaner and clean cloth (or paper towel) to remove any smudges, fingerprints, or oily residue from glass surface.</p>

TROUBLESHOOTING

CASE ISSUES	TROUBLESHOOTING METHOD
Product is drying out	<p>Make certain that product has not exceeded allotted display time.</p> <p><i>Authorized Personnel Only:</i></p> <ul style="list-style-type: none"> Adjust temperature control settings. See START-UP, OPERATION AND SHUTDOWN section for your model in this manual for instructions.
Product temperature deviates outside of acceptable range (product either overheating or too cool)	<ul style="list-style-type: none"> If deck or shelving contains few or no products, a temperature reading that is outside of range may be experienced. When case is properly stocked, air is trapped between product; temperatures should maintain proper range. Probe thermometer may be faulty. Use a stainless steel stem-type thermometer with dial of at least a 1-inch internal diameter and test product. Accuracy to within 1.8 °F / 1 °C is acceptable. <p><i>Authorized Personnel Only:</i></p> <ul style="list-style-type: none"> Adjust temperature control settings: See START-UP, OPERATION AND SHUTDOWN section for your model in this manual for instructions.
System is not operating at all	<p>Check that unit is properly plugged in.</p> <p>Confirm that the MAIN power switch is on.</p> <p>If power cord is used, confirm that it is plugged into outlet.</p> <p><i>Authorized Personnel Only:</i> Confirm that the utility power is on.</p> <p><i>Authorized Personnel Only:</i> Check the circuit breaker box for tripped circuits.</p> <p><i>Authorized Personnel Only:</i> GFCI may be required. If N.E.C. (National Electric Code) or your local code requires GFCI (Ground Fault Circuit Interrupter) protection, you MUST use a GFCI breaker in lieu of a GFCI receptacle.</p>
Product is not heating at all	<p>Heating elements may be malfunctioning.</p> <ul style="list-style-type: none"> Call Structural Concepts Technical Service (at last page of this manual). Move product to separate location until unit is repaired.
Ceramic metal halide lamps are not working	<p><i>Caution! Case is extremely hot! Turn off main power switch and allow lamps to cool for 45 minutes before touching light bulbs.</i></p> <ul style="list-style-type: none"> Be sure ALL lamps are inserted properly (and all the way for proper connection to take place). Check that bulbs are not burned out. It may take 15 minutes for ceramic metal halide lamps to fully illuminate.

STRUCTURAL CONCEPTS TECHNICAL SERVICE CONTACT INFORMATION & LIMITED WARRANTY

TECH SERVICE/WARRANTY CONTACT INFO: 1 (800) 433-9490 / EXTENSION 1

DAYS/HOURS AVAILABLE:
MONDAY - FRIDAY (CLOSED HOLIDAYS)
8:00 a.m. TO 5:00 p.m. EST

YOU MUST HAVE THE FOLLOWING INFO AVAILABLE BEFORE CONTACTING STRUCTURAL CONCEPTS:

SERIAL NO. / MODEL NO. / STORE NO. / STORE
ADDRESS / DETAILS (PHOTOS, LEAK LOCATIONS,
DAMAGE, STORE'S AMBIENT CONDITIONS, ETC.)

LIMITED WARRANTY

Overview: All sales by Structural Concepts Corporation (hereafter referred to as "SCC") are subject to the following limited warranty. "Goods" refers to the product or products being sold by SCC.

Warranty Scope: Warranty is for equipment sold in the United States, Canada, Mexico and Puerto Rico. Equipment sold elsewhere may carry modified warranties.

Warranty; Remedies; Limitations: The limit of liability of SCC toward the exchange cost of the original compressor motor (and/or any other components) is one year parts and labor. If any Goods are found to be of faulty material or workmanship within one year of the original F.O.B. (free on board) unit shipment, SCC will, at its option (after inspection by an authorized representative), replace or pay the reasonable cost of replacement of the faulty Goods. If warranty claim is not made within this one year time period, SCC is not bound to warrant Goods. A motor-compressor (and/or any other components) replaced during the warranty shall not exceed manufacturer's current established wholesaler's exchange price. If replacement motor-compressor (and/or other components) is available via storage facility, parts truck, etc., SCC mandates that readily accessible replacement components be used toward repair of Goods; in such instances, SCC will replace such equipment (at its own expense) after confirmation of its use/placement on defective unit. SCC shall not be charged an additional fee, up-charge or expense for such replacement Goods. If SCC is unable to repair or replace the defective Goods, SCC shall issue a credit to the Purchaser for full or partial purchase price, as SCC shall determine. The replacement or payment in the manner described above shall be the sole and exclusive remedy to Purchaser for a breach of this warranty. If any Goods are defective or fail to conform to this warranty, SCC will furnish instructions for their disposition. No Goods shall be returned to SCC without its prior consent.

SCC's liability for any defect in the Goods shall not exceed the purchase price of the Goods. SCC SHALL HAVE NO LIABILITY TO PURCHASER FOR CONSEQUENTIAL DAMAGES OF ANY KIND WHATSOEVER, INCLUDING, BUT NOT LIMITED TO, PERSONAL INJURY, PROPERTY DAMAGE, LOST PROFITS, OR OTHER ECONOMIC INJURY DUE TO ANY DEFECT IN THE GOODS OR ANY BREACH OF SCC, SCC SHALL NOT BE LIABLE TO THE PURCHASER IN TORT FOR ANY NEGLIGENT DESIGN OR MANUFACTURE OF THE GOODS, OR FOR THE OMISSION OF ANY WARNING THEREFROM.

SCC shall have no obligation or liability under this warranty for claims arising from any other party's (including Purchaser's) negligence or misuse of the Goods or environmental conditions. This warranty does not apply to any claim or damage arising from or caused by improper storage, handling, installation, maintenance, or from fire, flood, accidents, structural defects, building settlement or movement, acts of God, or other causes beyond SCC's control.

Except as expressly stated herein, SCC makes no warranty, express, implied, statutory or otherwise as to any parts or goods not manufactured by SCC. SCC shall warrant such parts or Goods only (I) against such defects, (II) for such periods of time, and (III) with such remedies, as are expressly warranted by the manufacturer of such parts of Goods. Notwithstanding the foregoing, any warranty with respect to such parts of Goods and any remedies available as a result of a breach thereof shall be subject to all of the procedures, limitations, and exclusions set forth herein.

THE WARRANTIES HEREIN ARE IN LIEU OF ALL WARRANTIES, EXPRESS, IMPLIED, STATUTORY, OR OTHERWISE. IN PARTICULAR, SCC MAKES NO WARRANTY OF MERCHANTABILITY OR FITNESS FOR A PARTICULAR PURPOSE.

No representative, agent or dealer of SCC has authority to modify, expand, or extend this Warranty, to waive any of the limitations or exclusions, or to make any different or additional warranties with respect to Goods.

Period of Limitations: No claim, suit or other proceeding may be brought by Purchaser for any breach of the foregoing warranty or this Agreement by SCC or in any way arising out of this Agreement or relating to the Goods after one year from the date of the breach. In the interpretation of this limitation on action for a breach by SCC, it is expressly agreed that there are no warranties of future performance of the goods that would extend that period of limitation herein contained for bringing an action.

Indemnifications: Purchaser agrees to indemnify, hold harmless, and defend SCC if so requested, from any and all liabilities, as defined herein, suffered, or incurred by SCC as a result of, or in connection with, any act, omission, or use of the Goods by Purchaser, its employees or customers, or any breach of this Agreement by Purchaser. Liabilities shall include all costs, claims, damages, judgments, and expenses (including reasonable attorney fees and costs).

Remedies of SCC: SCC's rights and remedies shall be cumulative and may be exercised from time to time. In a proceeding or action relating to the breach of this Agreement by Purchaser, Purchaser shall reimburse SCC for reasonable costs and attorney's fees incurred by SCC. No waiver by SCC of any breach of Purchaser shall be effective unless in writing nor operate as a waiver of any other breach of the same term thereafter. SCC shall not lose any right because it has not exercised it in the past.

Applicable Law: This Agreement is made in Michigan; it is governed by and interpreted according to Michigan law. Any lawsuit arising out of this Agreement or the Goods may be handled by a federal or state court whose district includes Muskegon County, Michigan, and Purchaser consents that such court shall have personal jurisdiction over Purchaser.

LED Lighting Components Within Lighting System: Supermarket: 5-year LED warranty from date of shipment. **Foodservice:** 2-year LED warranty from date of shipment. After one year, warranty does not include labor or other costs incurred for diagnosing, repairing, removing, installing, shipping, servicing, or handling of either defective part or replacement parts. Remedy of repair or provision of a replacement part without charge shall be the exclusive remedy for any warranty claim. The replacement LED and/or power supply assumes the unused portion of warranty remaining on unit(s). A 90-day warranty will apply for any LED sold as a service part. Warranty claim must include serial and model number of unit as well as date code on defective LED lighting component(s). Manufacturer may request return of defective part(s) at customer's expense to initiate claim.

Glass Material: Glass (UV-bonded glass, glass sneeze guards, glass enclosures, glass held in place via posts, etc.) is only warranted to FIRST POINT OF DELIVERY.

Miscellaneous: If any provision of this Agreement is found to be invalid or unenforceable under any law, the provision shall be ineffective to that extent and for the duration of the illegality, but the remaining provisions shall be unaffected. Purchaser shall not assign any of its rights nor delegate any of these obligations under this Agreement without prior written consent of SCC. This Agreement shall be binding upon and inure to the benefit of SCC and Purchaser and each of their legal representatives, successors and assignees. SCC warrants its products to be free of defects in materials and workmanship under normal use and service for a period of one (1) year from the date of delivery.

This warranty is extended only to the original purchaser for use of the Goods. It does not cover normal wear parts such as plastic tongs, tong holders, tong cables, bag holders, or acrylic dividers.

General Conditions: All service labor and/or parts charges are subject to approval by SCC. Contact Customer Service Dept. in writing, by phone, fax or email.

All claims must contain the following information: (1) model & serial code number of equipment; (2) the date and place of installation; (3) the name and address of the agency which performed the installation; (4) the date of the equipment failure; and (5) a complete description of the equipment failure and all circumstances relating to that failure.

Once the claim has been determined to be a true warranty claim by SCC's Customer Service Department, the following procedure will be taken: (1) replacement parts will be sent at no charge from SCC on a freight prepaid basis; (2) reimbursement for service labor will be paid if the following conditions have been met - (a) prior approval of service agency was awarded from the Customer Service Department; and (b) an itemized statement of all labor charges incurred is received by the Customer Service Department. The cost of the service labor reimbursement will be based on straight time rates and reasonable time for the repair of the defect.

If problems occur with any compressor, notify SCC's Customer Service Department immediately. Any attempt to repair or alter the unit without prior consent from the Customer Service Department will render any warranty claim null and void. This warranty and protection plan does not apply to any condensing unit or any part thereof which has been subject to accident, negligence, misuse, or abuse, or which has not been operated in accordance with the manufacturer's recommendations or if the serial number of the unit has been altered, defaced, or removed.

One Year Limit of Liability: After SCC's one-year parts and labor warranty on the original F.O.B. (free on board) unit has expired, SCC is not liable for either the equipment or labor costs of repairing or replacing the motor compressor, nor any other components that were included in the original F.O.B. (free on board) unit.